



Atop Technologies, Inc.

Industrial DIN-Rail Unmanaged Gigabit Ethernet Switch

EHG2308

8-port Industrial Unmanaged Gigabit Ethernet Switch

Hardware Installation Guide

Version 1.1

Updated on March, 2011



Tel: 886-3-5508137
Fax: 886-3-5508131
www.atop.com.tw

Introduction

Thank you for purchasing Atop EHG2308 Industrial Unmanaged Gigabit Ethernet Switch. This document intends to provide customers with brief descriptions about the product and to assist our customers to get started using our devices.

Inside the Package

- Main Product
 - One EHG2308 device
- Standard Accessories
 - Terminal block for power input
 - The hardcopy of Hardware Installation Guide
- Optional Accessories
 - US315-12(US), AC100V~240V 50/60HZ 12V/1.25A, US Plug (optional), → Atop PN:50500151120009G
 - US315-12(EU), AC100V~240V 50/60HZ 12V/1.25A, EU Plug (optional), → Atop PN:50500151120019G
 - Wall mount kit, 45.4*22.8mm(thick:1.5mm), Black color (optional), → Atop PN:201GW51CW37004G

Product Description

EHG2308 ▶

8-Port Industrial Unmanaged Gigabit Ethernet Switch

- 8 ports of 10/100/1000Base-TX with RJ45 connector
- 5 pins Terminal Block type of the power connector
- 2 LEDs with Power1(P1) and Power2(P2) status

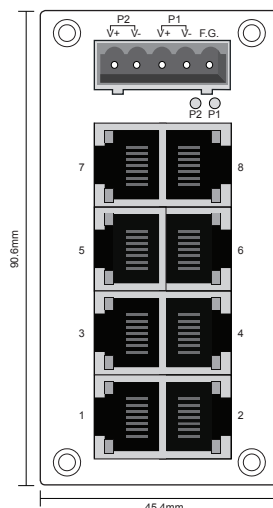

Hardware Installation

Step1: Installation on "Din-Rail"

- EHG2308 switch is equipped with a Din-Rail bracket attached onto the rear panel. Please follow the below steps to fasten the switch to the Din-Rail correctly.
- Tip the switch forward and press it against the Din-Rail after align the bracket springs to the Din-Rail.
- Press the bracket against the upper ledge of the Din-Rail until it clicks.

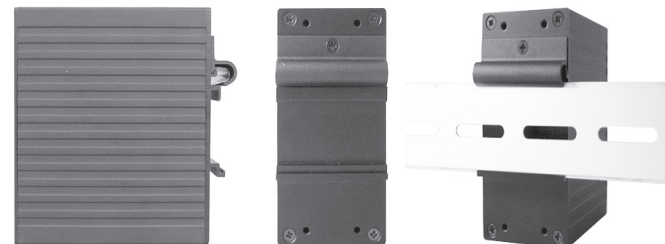

Notice :

The switches are designed to be mounted on a well-grounded place, such as a metal panel.

Step2: Connecting the Power

- Prepare the suitable power source and connect it into the switch by Terminal Blocks (TB5).
- DC 9-48V for EHG2308.
- You can connect two DC inputs into the switch power if auto-backup is needed.
- Check P1/P2 power LED. The LED(s) will be lighted when the device is ready.

5-pin Terminal Block for Power Input

Pin	V+	V-	F.G.
Signal	DC9-48V	0V	Frame Ground

Warning:

Before connecting the switch to the DC power input, please make sure the DC voltage supplied by the power source is correct and stable.

Step3: Connecting the Network Devices

- Connect your devices using standard UTP/STP cable with RJ-45 connectors to the switch. (For the cable wiring diagrams, please refer to the Pin Assignment)
- The corresponding RJ-45 LED will be lighted if the Ethernet connection is linked successfully.
- The LED will be blinked during data transfer by the switch.

※UL Notice for Power supplier

All the series of products are intended to be supplied by a Listed Power Unit marked with "LPS", "Limited Power Source" or "Class 2" with output rate 9-48VDC, 0.45A maximum. Or, use the recommended power supplies in "Optional Accessories".

LED Indicators

There are some LED indicators located at the front panel of the switch.

Name	LED	Status	Description
P1/P2	Green	Off	Power input 1/2 is not plugged yet
		On	Power status is ready
RJ-45	Green	Off	Link is broken, or no cable is plugged in
		Blink	The device is transferring data through the port
	Yellow	Off	The link is operated at rate of 10/100 Mbps
		On	The link is operated at rate of 1000 Mbps

Configuration and Setting Methods

Any settings or configuration is unnecessary.

Pin Assignment of Network Connections

RJ-45	PIN	MDI(1000base-T)	MDI(10/100base-T)
	1	TP1+	TX+
	2	TP1-	TX-
	3	TP2+	RX+
	4	TP3+	
	5	TP3-	
	6	TP2-	RX-
	7	TP4+	
	8	TP4-	

RJ-45 8-wiring normal definition

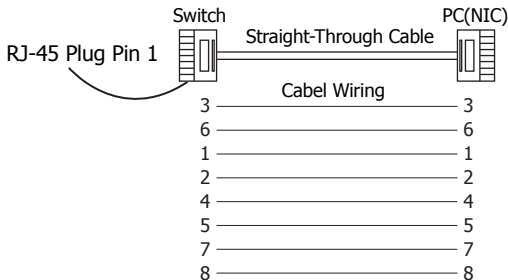

RJ-45 8-wiring Cross-Over definition

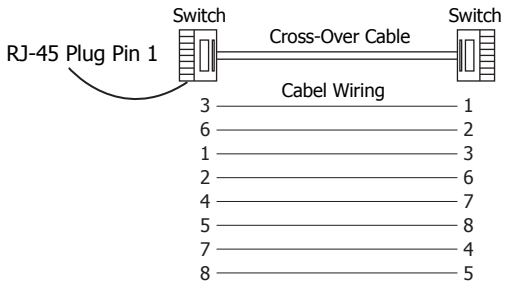

Mechanical dimensions(unit=mm)

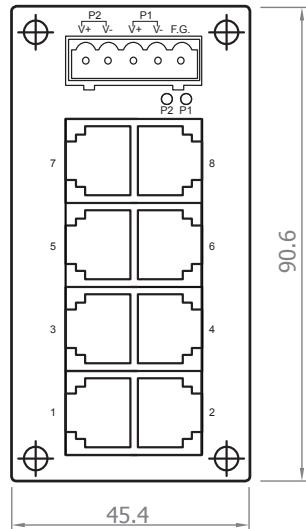

Front-panel view

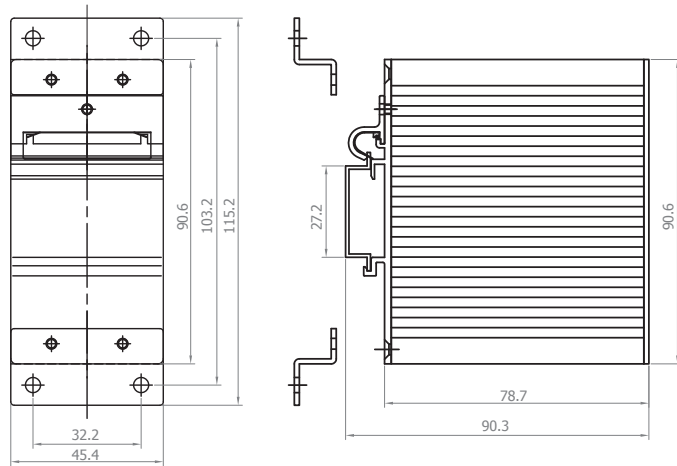

Backboard rear view

(Mount kit)

Housing side view

EHG2308 Front-panel view, Backboard rear view and Housing side view (including the optional mounting kit)

Warranty Policy

Warranty Conditions

Products supplied by Atop Technologies are covered in this warranty for sub-standard performance or defective workmanship. The warranty is not, however, extended to goods damaged in the following circumstances:

- (a) Excessive forces or impacts
- (b) War or an Act of God: wind storm, fire, flood, electric shock, earthquake
- (c) Use of unqualified power supply, connectors, or maintenance procedure
- (d) Replacement with unauthorized parts

RMA and Shipping Costs Reimbursement

Customers shall always obtain an authorized "RMA" number from Atop before shipping the goods to be repaired to Atop. When in normal use, a sold product shall be replaced with a new one within 3 months after purchase. The shipping cost from the customer to Atop will be reimbursed by Atop.

After 3 months and still within the warranty period, it is up to Atop whether to replace the unit with a new one; normally, as long as a product is under warranty, all parts and labor are free of charge to the customers.

After the warranty period, the customer shall cover the cost for parts and labor. Three months after purchase, the shipping cost from the customer to Atop will not be reimbursed, but the shipping cost from Atop to the customer will be paid by Atop.

Limited Liability

Atop shall not be held responsible for any consequential losses from using Atop's product.

Warranty Period

Product Categories	Warranty
Serial-to-Ethernet Server	5 Years
Serial-to WLAN Server	
Industrial Wireless Ethernet Device	
Modbus Gateway Series	
Industrial Ethernet Switch	
Embedded Serial Server	1 Year
Pick-to-Light System	
Auto-Identification and Data Collection-AIDC	

※ **Warranty coverage for accessories such as power adapters and high-gain antenna is one year.**

The warranty certification will not be effective until an authorized stamp issued by Atop's overseas agents.

Purchase Date: / / (yyyy/mm/dd)

Serial Number:



ATOP Customer Services and Supports

1. Please contact your local dealers or Atop Technical Support Center at the following numbers.
 - + 886-3-550-8137 (Atop Taiwan)
 - + 86-21-6495-6232 (Atop China)
2. Please report the defected problems via Atop's Web site or E-mail account
 - Web Site : www.atop.com.tw, e-mail : service@atop.com.tw
 - Web Site : www.atop.com.cn, e-mail : service@atop.com.cn